



Electrical Conduits



MTK
MADE IN TURKEY



Steel and Plastic Electrical Conduits

Galvanized Flexible Steel Conduits

Çelik Spiral Boru

Металрукав из оцинкованной стали

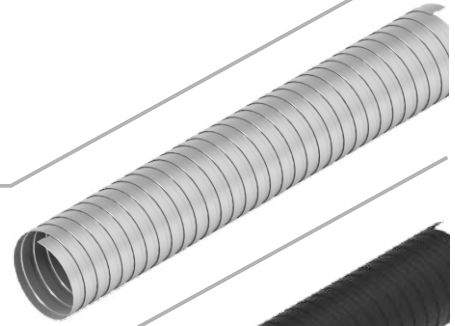

PVC Coated Flexible Steel Conduit

PVC Kaplı Çelik Spiral Boru

Металрукав в ПВХ оболочке



PVC Spiral Pipe Flame-retardant

PVC Spiral boru

Гофрированная труба из ПВХ



PE Spiral Pipe Halogen Free

PE Spiral boru

Гофрированная труба из полиэтилена



PA6 Polyamid Spiral Pipes

PA6 Spiral boru

Гофрированная труба из полиамида



PVC Rigit Pipes Flame-retardant Cold Bendable

PVC Düz boru

Жесткая гладкостенная труба из ПВХ



EMT Galvanised Steel Conduits

Galvaniz EMT boru

Оцинкованная стальная труба жесткая



RSC Galvanised Steel Conduits (threaded ends)

Galvaniz RSC boru, dişli

Оцинкованная стальная труба с наружной резьбой



PE Spiral Pipe Halogen Free

PE Spiral boru - Гофрированная труба из полиэтилена

Specification							
Material		PE based Thermoplastic					
Compression Ressitance		125 Newton / 60sec	125 Newton / 60sec	320 Newton / 60sec	320 Newton / 60sec	750 Newton / 60sec	750 Newton / 60sec
Flame Retardant		Halogen Free					
Temperature Ressitance		-25 C/ +60 C	-25 C/ +60 C	-25 C/ +60 C	-25 C/ +60 C	-25 C/ +60 C	-25 C/ +60 C
Color Options		Ral 2004; Ral 7035; Ral 9003					
Size ID mm	in rol, meter	Codes (Conduits)					
16	100	HFO 016	HFO 116	HF1 016	HF1 116	HF3 016	HF3 116
20	100	HFO 020	HFO 120	HF1 020	HF1 120	HF3 020	HF3 120
25	50	HFO 025	HFO 125	HF1 025	HF1 125	HF3 025	HF3 125
32	50	HFO 032	HFO 132	HF1 032	HF1 132	HF3 032	HF3 132
40	50	HFO 040	HFO 140	HF1 040	HF1 140	HF3 040	HF3 140
50	25	HFO 050	HFO 150	HF1 050	HF1 150	HF3 050	HF3 150

PP Spiral Pipe Halogen Free

PP Spiral boru - Гофрированная труба из полипропилена

Specification					
Material		PP based Thermoplastic			
Compression Ressitance		320 Newton / 60sec	320 Newton / 60sec	750 Newton / 60sec	750 Newton / 60sec
Flame Retardant		Halogen Free			
Temperature Ressitance		-25 C/ +60 C	-25 C/ +60 C	-25 C/ +60 C	-25 C/ +60 C
Color Options		Ral 7035, Ral 7031, RAL 2004, RAL 9003, RAL 9005			
Size ID mm	in rol, meter	Codes (Conduits)			
16	100	FR1 016	FR1 116	FR3 016	FR3 116
20	100	FR1 020	FR1 120	FR3 020	FR3 120
25	50	FR1 025	FR1 125	FR3 025	FR3 125
32	50	FR1 032	FR1 132	FR3 032	FR3 132
40	50	FR1 040	FR1 140	FR3 040	FR3 140
50	25	FR1 050	FR1 150	FR3 050	FR3 150

Spiral Pipe Coupling Halogen Free



Order code	Ø
GFS-16-S	16
GFS-20-S	20
GFS-25-S	25
GFS-32-S	32

Spiral Pipe Coupling Halogen Free



Order code	Ø
CFS-16-PP	16
CFS-20-PP	20
CFS-25-PP	25
CFS-32-PP	32

Tweezers clip



Order code
CMK 8/28
CMK 3/13

Stick clip double



Order code
CFK 20
CFK 25

PA6 Polyamid Spiral Pipes

PA6 Spiral boru - Гофрированная труба из полиамида

Specification		UL 94 DIN EN ISO 8580	UL 94 DIN EN ISO 8580		METRIC THREAD	
Material	PA6 Polyamid- HF		Polyamid PA6	Polyamid PA6	Polyamid PA6	
Permanent Vibration	DIN 55442, high flexibility	Flame-retardant, UV	Flame-retardant	Flame-retardant	Flame-retardant	Flame-retardant
Flame Retardant	V-DIN 75200 -HF	V-DIN 75200 -HF	Halogen Free	Halogen Free	Halogen Free	Halogen Free
Compression Resistance	750 Newton /60 sec	750 Newton /60 sec				
Color Options	Black-Grey (Ral 7031)					
Size ID mm	in rol, meter	Codes (Conduits)				
5	100	PA6 5	PA6 Vo 5			
7	100	PA6 7	PA6 Vo 7	RPG 7	RM 7	CL 7
8.5	100	PA6 8.5	PA6 Vo 8.5	RPG 8.5	RM 8.5	CL 8.5
10	100	PA6 10	PA6 Vo 10	RPG 10	RM 10	CL 10
12	50	PA6 12	PA6 Vo 12	RPG 12	RM 12	CL 12
14	50	PA6 14	PA6 Vo 14	RPG 14	RM 14	CL 14
17	50	PA6 17	PA6 Vo 17	RPG 17	RM 17	CL 17
19	50	PA6 19	PA6 Vo 19			
22	50	PA6 22	PA6 Vo 22	RPG 22	RM 22	CL 22
23	50	PA6 23	PA6 Vo 23			
26	25	PA6 26	PA6 Vo 26			
29	25	PA6 29	PA6 Vo 29	RPG 29	RM 29	CL 29
36	25	PA6 36	PA6 Vo 36	RPG 36	RM 36	CL 36
48	25	PA6 48	PA6 Vo 48	RPG 48	RM 48	CL 48

PVC Rigit Pipes Flame-retardant Cold Bendable

PVC Düz boru - Жесткая гладкостенная труба из ПВХ

Specification		Cold Bendable	Cold Bendable	Cold Bendable	Coupler	Clip
Material	PVC base termoplastic					
Temperature Ressitance	-25 C/ +60 C	-25 C/ +60 C	-25 C/ +60 C	-25 C/ +60 C	-25 C/ +60 C	-25 C/ +60 C
Flame Retardant	Flame-retardant					
Compression Resistance	320 Newton /60 sec	750 Newton /60 sec	1250 Newton /60 sec			
Color Options	RAL 7035, RAL 9003, RAL 9005			RAL 7035, RAL 9005		
Size ID mm	in rol, meter	Codes (Conduits)				
16	102	SR1 316	SR2 316	SR3 316	GSS-16-PVC	CYS-16-PVC
20	102	SR1 320	SR2 320	SR3 320	GSS-20-PVC	CYS-20-PVC
25	75	SR1 325	SR2 325	SR3 325	GSS-25-PVC	CYS-25-PVC
32	51	SR1 332	SR2 332	SR3 332	GSS-32-PVC	CYS-32-PVC
40	51	SR1 340	SR2 340	SR3 340	GSS-40-PVC	CYS-40-PVC
50	30	SR1 350	SR2 350	SR3 350	GSS-50-PVC	CYS-50-PVC

PVC Elbow Bend Flame-retardant



CRA

PVC Elbow Bend 90°



ADS

PVC T Joint



TBS



PE Spiral Pipe - Halogen Free - Very Light Duty (125 Newton)

PE Spiral Boru – Halojensiz / Çok Hafif Seri (125 N) - Спиральная труба PE, без галогенов, очень лёгкая серия (125 Н)

ECO TYPE / Without Wire Puller



Kılavuz Telsiz

APLICATION FIELDS

Used in flush mounted and surface mounted applications, walls and suspended ceilings, under plaster and electrical installations where low mechanical stress is expected.

Standard Color

Orange:
RAL:2004

Turuncu

HF0 0...							
Product Code	Size mm	Inside D mm	Outside D mm	Puller	Standard Color	Package mt	Package Volume m ³
HF0 016	16	11,5	16	without puller	Orange	100	0,0380
HF0 020	20	14,8	20	without puller	Orange	100	0,0510
HF0 025	25	18,8	25	without puller	Orange	50	0,0410
HF0 032	32	25,1	32	without puller	Orange	50	0,0460
HF0 040	40	31,5	40	without puller	Orange	50	0,0640
HF0 050	50	40	50	without puller	Orange	25	0,0840

Other color options:

Beyaz

White:
RAL:9003

Prod. Code	Size
HF0 016 B	16
HF0 020 B	20
HF0 025 B	25
HF0 032 B	32
HF0 040 B	40
HF0 050 B	50

Açık Gri

Light Grey
RAL:7035

Prod. Code	Size
HF0 016 G	16
HF0 020 G	20
HF0 025 G	25
HF0 032 G	32
HF0 040 G	40
HF0 050 G	50

PE Spiral Pipe - Halogen Free - Very Light Duty (125 Newton)

PE Spiral Boru – Halojensiz / Çok Hafif Seri (125 N)

Спиральная труба PE, без галогенов, лёгкая серия (125 Н)

ECO TYPE / WITH WIRE PULLER



Kılavuz Telli

APLICATION FIELDS

Used in flush mounted and surface mounted applications, walls and suspended ceilings, under plaster and electrical installations where low mechanical stress is expected.

Standard Color

Orange:
RAL:2004

Turuncu

HF0 1...							
Model Number	Size mm	Inside D mm	Outside D mm	Puller	Standard Color	Package mt	Package Volume m ³
HF0 116	16	11,5	16	with puller	Orange	100	0,0380
HF0 120	20	14,8	20	with puller	Orange	100	0,0510
HF0 125	25	18,8	25	with puller	Orange	50	0,0410
HF0 132	32	25,1	32	with puller	Orange	50	0,0460
HF0 140	40	31,5	40	with puller	Orange	50	0,0640
HF0 150	50	40	50	with puller	Orange	25	0,0840

Other color options:

Beyaz

White:
RAL:9003

Prod. Code	Size
HF0 116 B	16
HF0 120 B	20
HF0 125 B	25
HF0 132 B	32
HF0 140 B	40
HF0 150 B	50

Açık Gri

Light Grey
RAL:7035

Prod. Code	Size
HF0 116 G	16
HF0 120 G	20
HF0 125 G	25
HF0 132 G	32
HF0 140 G	40
HF0 150 G	50

Technical Features	
Material	PE Based Thermoplastic
Compression Resistance	125 Newton / 60 Sec Class 1
Impact Resistance	1 Kg / 100 mm Class 2
Temperature Resistance	-25°C / +60°C Class 4/1
Insulation Strength	2000 V/ 50 Hz / 15 min
Insulation Resistance	>100 MΩ / 60 sec / 500 V

Turuncu

Orange:
RAL:2004

Beyaz

White:
RAL:9003

Açık Gri

Light Gray:
RAL:7035

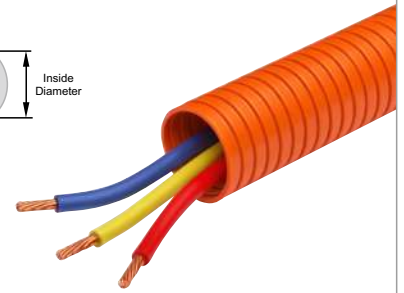

Technical Features	
Material	PE Based Thermoplastic
Compression Resistance	125 Newton / 60 Sec Class 1
Impact Resistance	1 Kg / 100 mm Class 2
Temperature Resistance	-25°C / +60°C Class 4/1
Insulation Strength	2000 V/ 50 Hz / 15 min
Insulation Resistance	>100 MΩ / 60 sec / 500 V

Turuncu

Orange:
RAL:2004

Beyaz

White:
RAL:9003

Açık Gri

Light Gray:
RAL:7035

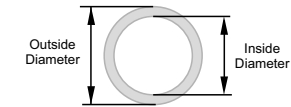

PE Spiral Pipe – Halogen Free – Light Duty (320 Newton)

PE Spiral Boru – Halojensiz – Hafif Seri (320 N) - Спиральная труба PE, без галогенов, лёгкая серия (320 Н)



Without Wire Puller

Standard Color
Orange: RAL:2004
Turuncu

APPLICATION FIELDS
Used in flush mounted and surface mounted applications, walls and suspended ceilings, under plaster and electrical installations where low mechanical stress is expected.

HF1 0...

Product Code	Size mm	Inside D mm	Outside D mm	Puller	Standard Color	Package mt	Package Volume m3
HF1 016	16	11,2	16	without puller	Orange	100	0,0380
HF1 020	20	14,6	20	without puller	Orange	100	0,0510
HF1 025	25	18,6	25	without puller	Orange	50	0,0410
HF1 032	32	24,8	32	without puller	Orange	50	0,0460
HF1 040	40	31,2	40	without puller	Orange	50	0,0640
HF1 050	50	39,6	50	without puller	Orange	25	0,0840

Other color options:

Beyaz

White: RAL:9003

Prod. Code	Size
HF1 016 B	16
HF1 020 B	20
HF1 025 B	25
HF1 032 B	32
HF1 040 B	40
HF1 050 B	50

Açık Gri

Light Grey: RAL:7035

Prod. Code	Size
HF1 016 G	16
HF1 020 G	20
HF1 025 G	25
HF1 032 G	32
HF1 040 G	40
HF1 050 G	50

Technical Features

Material	PE Based Thermoplastic	
Compression Resistance	320 Newton / 60 Sec	Class 2
Impact Resistance	1 Kg / 100 mm	Class 2
Temperature Resistance	-25°C / +60°C	Class 4/1
Insulation Strength	2000 V / 50 Hz / 15 min	
Insulation Resistance	>100 MΩ / 60 sec / 500 V	

Turuncu

Orange: RAL:2004

Beyaz

White: RAL:9003

Açık Gri

Light Gray: RAL:7035

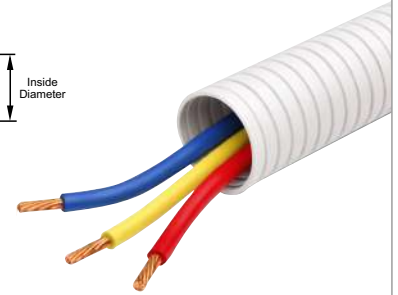

PE Spiral Pipe – Halogen Free – Light Duty (320 Newton)

PE Spiral Boru – Halojensiz – Hafif Seri (320 N)

Спиральная труба PE, без галогенов, лёгкая серия (320 Н)



With Wire Puller

Kilavuz Telli

Standard Color
Orange: RAL:2004
Turuncu

APPLICATION FIELDS
Used in flush mounted and surface mounted applications, walls and suspended ceilings, under plaster and electrical installations where low mechanical stress is expected.

HF1 1...

Product Code	Size mm	Inside D mm	Outside D mm	Puller	Standard Color	Package mt	Package Volume m3
HF1 116	16	11,2	16	with puller	Orange	100	0,0380
HF1 120	20	14,6	20	with puller	Orange	100	0,0510
HF1 125	25	18,6	25	with puller	Orange	50	0,0410
HF1 132	32	24,8	32	with puller	Orange	50	0,0460
HF1 140	40	31,2	40	with puller	Orange	50	0,0640
HF1 150	50	39,6	50	with puller	Orange	25	0,0840

Other color options:

Beyaz

White: RAL:9003

Prod. Code	Size
HF1 116 B	16
HF1 120 B	20
HF1 125 B	25
HF1 132 B	32
HF1 140 B	40
HF1 150 B	50

Açık Gri

Light Grey: RAL:7035

Prod. Code	Size
HF1 116 G	16
HF1 120 G	20
HF1 125 G	25
HF1 132 G	32
HF1 140 G	40
HF1 150 G	50

Technical Features

Material	PE Based Thermoplastic	
Compression Resistance	320 Newton / 60 Sec	Class 2
Impact Resistance	1 Kg / 100 mm	Class 2
Temperature Resistance	-25°C / +60°C	Class 4/1
Insulation Strength	2000 V / 50 Hz / 15 min	
Insulation Resistance	>100 MΩ / 60 sec / 500 V	

Turuncu

Orange: RAL:2004

Beyaz

White: RAL:9003

Açık Gri

Light Gray: RAL:7035

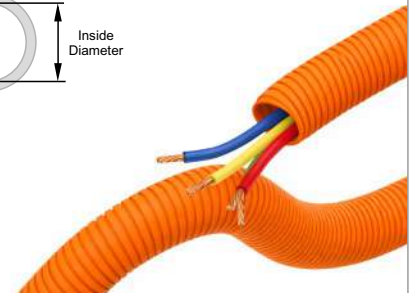

PE Spiral Pipes



MTK
MADE IN TURKEY

PE Spiral Pipe – Halogen Free – Heavy Duty (750 Newton)

PE Spiral Boru – Halojeniz – Ağır Seri (750 N) - Спиральная труба PE, без галогенов, тяжёлая серия (750 Н)



Without Wire Puller

Kılavuz Telsiz

Standard Color

Orange:
RAL:2004

Turuncu

HF3 0...							
Model Number	Size mm	Inside D mm	Outside D mm	Puller	Standard Color	Package mt	Package Volume m3
HF3 016	16	10,9	16	without puller	Orange	100	0,0380
HF3 020	20	14,3	20	without puller	Orange	100	0,0510
HF3 025	25	18,2	25	without puller	Orange	50	0,0410
HF3 032	32	24,4	32	without puller	Orange	50	0,0460
HF3 040	40	30,8	40	without puller	Orange	50	0,0640
HF3 050	50	39,1	50	without puller	Orange	25	0,0840

Other color options:

Beyaz

White: RAL:9003

Prod. Code	Size
HF3 016 B	16
HF3 020 B	20
HF3 025 B	25
HF3 032 B	32
HF3 040 B	40
HF3 050 B	50

Açık Gri

Light Grey RAL:7035

Prod. Code	Size
HF3 016 G	16
HF3 020 G	20
HF3 025 G	25
HF3 032 G	32
HF3 040 G	40
HF3 050 G	50

Technical Features

Material	PE Based Thermoplastic	
Compression Resistance	750 Newton / 60 Sec	Class 3
Impact Resistance	2 Kg / 100 mm	Class 3
Temperature Resistance	-25 C/ +60C	Class 4/1
Insulation Strength	2000 V/ 50 Hz / 15 min	
Insulation Resistance	>100 MΩ / 60 sec / 500 V	

Turuncu

Orange: RAL:2004

Beyaz

White: RAL:9003

Açık Gri

Light Gray: RAL:7035

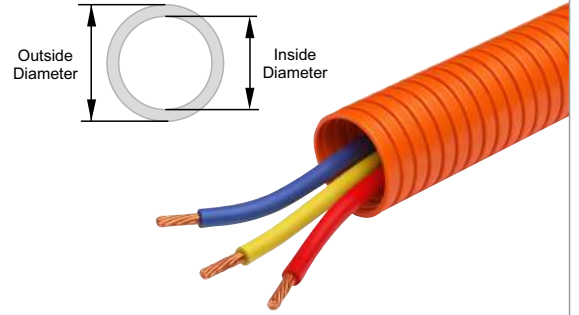

PE Spiral Pipe – Halogen Free – Heavy Duty (750 Newton)

PE Spiral Boru – Halojeniz – Ağır Seri (750 N)

Спиральная труба PE, без галогенов, тяжёлая серия (750 Н)



With Wire Puller

Kılavuz Telli

Standard Color

Orange:
RAL:2004

Turuncu

HF3 1...							
Model Number	Size mm	Inside D mm	Outside D mm	Puller	Standard Color	Package mt	Package Volume m3
HF3 116	16	10,9	16	with wire puller	Orange	100	0,0380
HF3 120	20	14,3	20	with wire puller	Orange	100	0,0510
HF3 125	25	18,2	25	with wire puller	Orange	50	0,0410
HF3 132	32	24,4	32	with wire puller	Orange	50	0,0460
HF3 140	40	30,8	40	with wire puller	Orange	50	0,0640
HF3 150	50	39,1	50	with wire puller	Orange	25	0,0840

Other color options:

Beyaz

White: RAL:9003

Prod. Code	Size
HF3 116 B	16
HF3 120 B	20
HF3 125 B	25
HF3 132 B	32
HF3 140 B	40
HF3 150 B	50

Açık Gri

Light Grey RAL:7035

Prod. Code	Size
HF3 116 G	16
HF3 120 G	20
HF3 125 G	25
HF3 132 G	32
HF3 140 G	40
HF3 150 G	50

Technical Features

Material	PE Based Thermoplastic	
Compression Resistance	750 Newton / 60 Sec	Class 3
Impact Resistance	2 Kg / 100 mm	Class 3
Temperature Resistance	-25 C/ +60C	Class 4/1
Insulation Strength	2000 V/ 50 Hz / 15 min	
Insulation Resistance	>100 MΩ / 60 sec / 500 V	

Turuncu

Orange: RAL:2004

Beyaz

White: RAL:9003

Açık Gri

Light Gray: RAL:7035

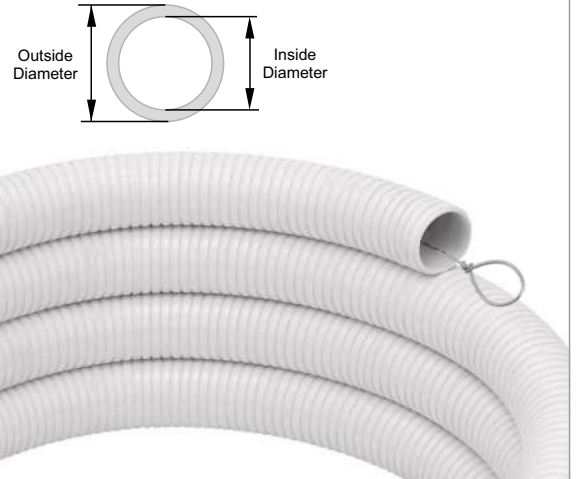

PP Spiral Pipe – Halogen Free – Flame Retardant - Light Duty (320 Newton)

PP Spiral Boru – Halojensiz – Alev Yayımayan Hafif Seri (320 N) - Спиральная труба из PP, без галогенов, лёгкая серия (320 H)

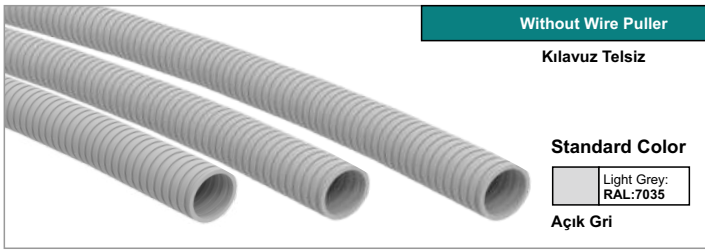

Without Wire Puller

Kılavuz Telsiz

Standard Color

Light Grey:
RAL:7035

Açık Gri

FR1 0...

Model Number	Size mm	Inside D mm	Outside D mm	Puller	Standard Color	Package mt	Package Volume m ³
FR1 016	16	11,2	16	without puller	Light Grey	100	0,0380
FR1 020	20	14,6	20	without puller	Light Grey	100	0,0510
FR1 025	25	18,6	25	without puller	Light Grey	50	0,0410
FR1 032	32	24,8	32	without puller	Light Grey	50	0,0460
FR1 040	40	31,2	40	without puller	Light Grey	50	0,0640
FR1 050	50	39,6	50	without puller	Light Grey	25	0,0840

Other color options:



Blue Grey
RAL:7031

Orange:
RAL:2004

White
RAL:9003

Black
RAL:9005

Prod. Code	Size
FR1 016 M	16
FR1 020 M	20
FR1 025 M	25
FR1 032 M	32
FR1 040 M	40
FR1 050 M	50

Prod. Code	Size
FR1 016 T	16
FR1 020 T	20
FR1 025 T	25
FR1 032 T	32
FR1 040 T	40
FR1 050 T	50

Prod. Code	Size
FR1 016 B	16
FR1 020 B	20
FR1 025 B	25
FR1 032 B	32
FR1 040 B	40
FR1 050 B	50

Prod. Code	Size
FR1 016 S	16
FR1 020 S	20
FR1 025 S	25
FR1 032 S	32
FR1 040 S	40
FR1 050 S	50

PP Spiral Pipe – Halogen Free – Flame Retardant Light Duty (320 Newton)

PP Spiral Boru – Halojensiz – Alev Yayımayan Hafif Seri (320 N)
Спиральная труба из PP, без галогенов, лёгкая серия (320 H)



With Wire Puller

Kılavuz Telli

Standard Color

Light Grey:
RAL:7035

Açık Gri

FR1 1...

Model Number	Size mm	Inside D mm	Outside D mm	Puller	Standard Color	Package mt	Package Volume m ³
FR1 116	16	11,2	16	with puller	Light Grey	100	0,0380
FR1 120	20	14,6	20	with puller	Light Grey	100	0,0510
FR1 125	25	18,6	25	with puller	Light Grey	50	0,0410
FR1 132	32	24,8	32	with puller	Light Grey	50	0,0460
FR1 140	40	31,2	40	with puller	Light Grey	50	0,0640
FR1 150	50	39,6	50	with puller	Light Grey	25	0,0840

Other color options:



Blue Grey
RAL:7031

Orange:
RAL:2004

White
RAL:9003

Black
RAL:9005

Prod. Code	Size
FR1 116 M	16
FR1 120 M	20
FR1 125 M	25
FR1 132 M	32
FR1 140 M	40
FR1 150 M	50

Prod. Code	Size
FR1 116 T	16
FR1 120 T	20
FR1 125 T	25
FR1 132 T	32
FR1 140 T	40
FR1 150 T	50

Prod. Code	Size
FR1 116 B	16
FR1 120 B	20
FR1 125 B	25
FR1 132 B	32
FR1 140 B	40
FR1 150 B	50

Prod. Code	Size
FR1 116 S	16
FR1 120 S	20
FR1 125 S	25
FR1 132 S	32
FR1 140 S	40
FR1 150 S	50

Technical Features

Material	PP Based Thermoplastic	
Compression Resistance	320 Newton / 60 Sec	Class 2
Impact Resistance	1 Kg / 100 mm	Class 2
Temperature Resistance	-25 C/ +60C	Class 4/1
Insulation Strength	2000 V/ 50 Hz / 15 min	
Insulation Resistance	>100 MΩ / 60 sec / 500 V	

Açık Gri

Light Gray:
RAL:7035

Mavi Gri

Blue Gray:
RAL:7031

Turuncu

Orange:
RAL:2004

Beyaz

White:
RAL:9003

Siyah

Black:
RAL:9005

APPLICATION FIELDS

Used in flush mounted and surface mounted applications, walls and suspended ceilings, under plaster and electrical installations where low mechanical stress is expected.

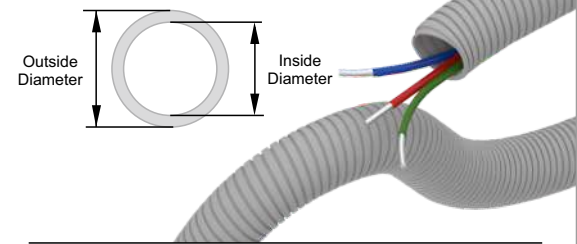

Technical Features

Material	PP Based Thermoplastic	
Compression Resistance	320 Newton / 60 Sec	Class 2
Impact Resistance	1 Kg / 100 mm	Class 2
Temperature Resistance	-25 C/ +60C	Class 4/1
Insulation Strength	2000 V/ 50 Hz / 15 min	
Insulation Resistance	>100 MΩ / 60 sec / 500 V	

Açık Gri

Light Gray:
RAL:7035

Mavi Gri

Blue Gray:
RAL:7031

Turuncu

Orange:
RAL:2004

Beyaz

White:
RAL:9003

Siyah

Black:
RAL:9005

APPLICATION FIELDS

Used in flush mounted and surface mounted applications, walls and suspended ceilings, under plaster and electrical installations where low mechanical stress is expected.

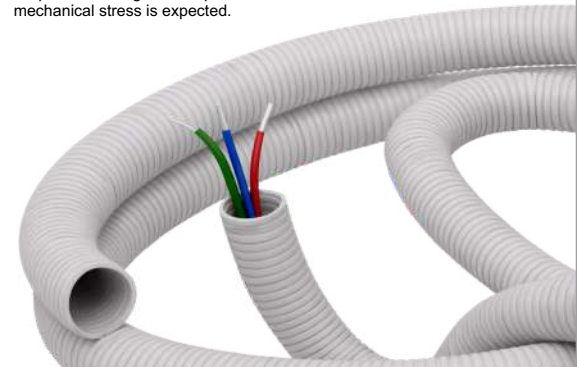

PP Spiral Pipes



MTK
MADE IN TURKEY

PP Spiral Pipe – Halogen Free – Flame Retardant - Heavy Duty (750 Newton)

PP Spiral Boru – Halojensiz – Alev Yaymayan Ağır Seri (750 N) - Спиральная труба из PP, без галогенов, тяжёлая серия (750 H)

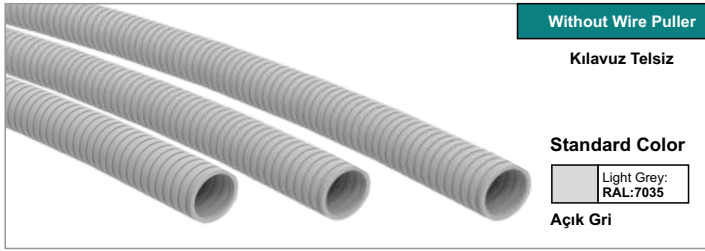

Without Wire Puller

Kılavuz Telsiz

Standard Color

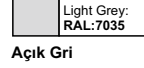

Açık Gri

FR3 0...

Model Number	Size mm	Inside D mm	Outside D mm	Puller	Standard Color	Package mt	Package Volume m ³
FR3 016	16	10,9	16	without puller	Light Grey	100	0,0380
FR3 020	20	14,3	20	without puller	Light Grey	100	0,0510
FR3 025	25	18,2	25	without puller	Light Grey	50	0,0410
FR3 032	32	24,4	32	without puller	Light Grey	50	0,0460
FR3 040	40	30,8	40	without puller	Light Grey	50	0,0640
FR3 050	50	39,1	50	without puller	Light Grey	25	0,0840

Other color options:



Prod. Code	Size	Prod. Code	Size	Prod. Code	Size	Prod. Code	Size
FR3 016 M	16	FR3 016 T	16	FR3 016 B	16	FR3 016 S	16
FR3 020 M	20	FR3 020 T	20	FR3 020 B	20	FR3 020 S	20
FR3 025 M	25	FR3 025 T	25	FR3 025 B	25	FR3 025 S	25
FR3 032 M	32	FR3 032 T	32	FR3 032 B	32	FR3 032 S	32
FR3 040 M	40	FR3 040 T	40	FR3 040 B	40	FR3 040 S	40
FR3 050 M	50	FR3 050 T	50	FR3 050 B	50	FR3 050 S	50

PP Spiral Pipe – Halogen Free – Flame Retardant - Heavy Duty (750 Newton)

PP Spiral Boru – Halojensiz – Alev Yaymayan Ağır Seri (750 N)

Спиральная труба из PP, без галогенов, тяжёлая серия (750 H)



With Wire Puller

Kılavuz Telli

Standard Color



FR3 1...

Model Number	Size mm	Inside D mm	Outside D mm	Puller	Standard Color	Package mt	Package Volume m ³
FR3 116	16	10,9	16	with puller	Light Grey	100	0,0380
FR3 120	20	14,3	20	with puller	Light Grey	100	0,0510
FR3 125	25	18,2	25	with puller	Light Grey	50	0,0410
FR3 132	32	24,4	32	with puller	Light Grey	50	0,0460
FR3 140	40	30,8	40	with puller	Light Grey	50	0,0640
FR3 150	50	39,1	50	with puller	Light Grey	25	0,0840

Other color options:

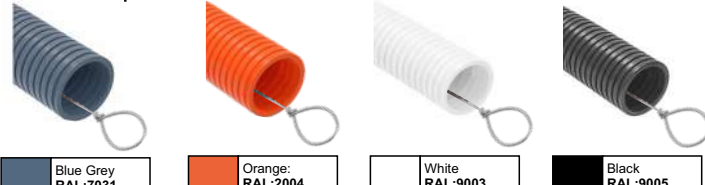

Prod. Code	Size	Prod. Code	Size	Prod. Code	Size	Prod. Code	Size
FR3 116 M	16	FR3 116 T	16	FR3 116 B	16	FR3 016 S	16
FR3 120 M	20	FR3 120 T	20	FR3 120 B	20	FR3 020 S	20
FR3 125 M	25	FR3 125 T	25	FR3 125 B	25	FR3 025 S	25
FR3 132 M	32	FR3 132 T	32	FR3 132 B	32	FR3 032 S	32
FR3 140 M	40	FR3 140 T	40	FR3 140 B	40	FR3 040 S	40
FR3 150 M	50	FR3 050 T	50	FR3 150 B	50	FR3 050 S	50

Technical Features

Material	PP Based Thermoplastic	
Compression Resistance	750 Newton / 60 Sec	Class 3
Impact Resistance	2 Kg / 100 mm	Class 3
Temperature Resistance	-25 C/ +60C	Class 4/1
Insulation Strength	2000 V/ 50 Hz / 15 min	
Insulation Resistance	>100 MΩ / 60 sec / 500 V	

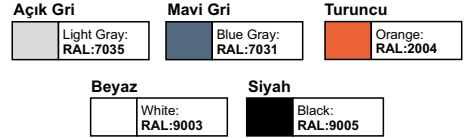

APPLICATION FIELDS

Used in flush mounted and surface mounted applications, walls and suspended ceilings, under plaster and electrical installations where low mechanical stress is expected.

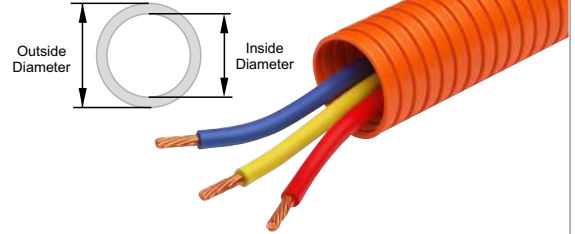

Technical Features

Material	PP Based Thermoplastic	
Compression Resistance	750 Newton / 60 Sec	Class 3
Impact Resistance	2 Kg / 100 mm	Class 3
Temperature Resistance	-25 C/ +60C	Class 4/1
Insulation Strength	2000 V/ 50 Hz / 15 min	
Insulation Resistance	>100 MΩ / 60 sec / 500 V	

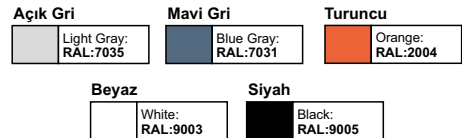

APPLICATION FIELDS

Used in flush mounted and surface mounted applications, walls and suspended ceilings, under plaster and electrical installations where low mechanical stress is expected.

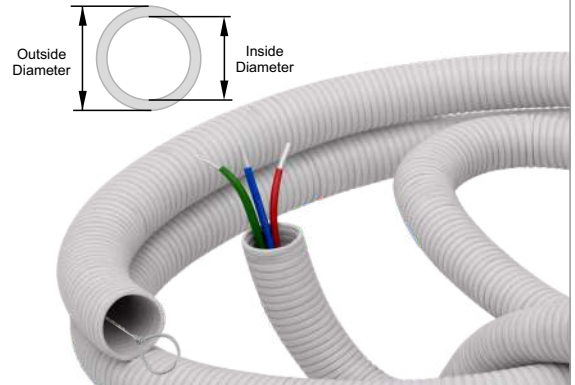

PA6 Polyamid Spiral Pipes

PA6 Polyamid Corrugur Boru - Гофрированная труба из полиамида



Model Number	Size mm	Inside D mm	Outside D mm	Puller	Package mt	Package Volume m ³
PA6 5	5	5,1	7,1	without puller	100	0,0120
PA6 7	7	6,35	10	without puller	100	0,0106
PA6 8,5	8,5	8,8	11,7	without puller	50	0,0135
PA6 10	10	9,6	13,2	without puller	50	0,0175
PA6 12	12	12,1	15,8	without puller	50	0,0250
PA6 14	14	13,9	18,4	without puller	25	0,0317
PA6 17	17	16,3	21,4	without puller	100	0,0384
PA6 19	19	19,2	24,1	without puller	100	0,0510
PA6 22	22	21,5	25,4	without puller	100	0,0567
PA6 23	23	22,8	28,7	without puller	50	0,0588
PA6 26	26	25,7	31	without puller	50	0,0406
PA6 29	29	28,6	34,5	without puller	50	0,0483
PA6 36	36	35,7	42,5	without puller	25	0,0714
PA6 48	48	47,2	54,4	without puller	100	0,0840

PA6 Polyamid Spiral Pipes - Flame Retardant

PA6 Polyamid Corrugur Boru - Гофрированная труба из полиамида

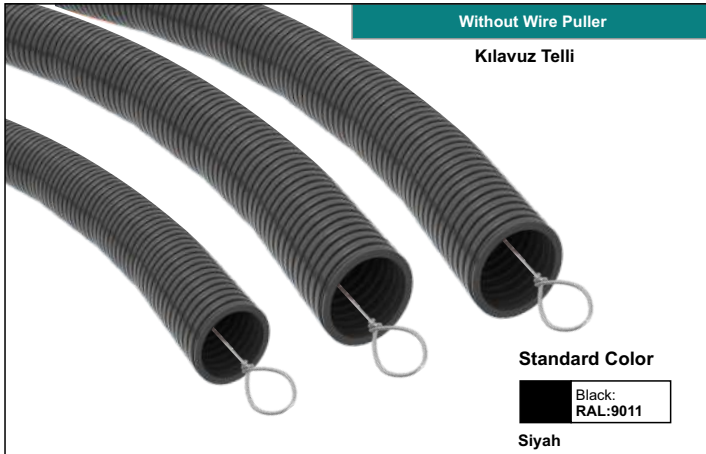

Model Number	Size mm	Inside D mm	Outside D mm	Puller	Package mt	Package Volume m ³
PA6 Vo 5	5	5,1	7,10	with wire puller	100	0,0120
PA6 Vo 7	7	6,35	10	with wire puller	50	0,0106
PA6 Vo 8,5	8,5	8,8	11,7	with wire puller	50	0,0135
PA6 Vo 10	10	9,6	13,2	with wire puller	50	0,0175
PA6 Vo 12	12	12,1	15,8	with wire puller	50	0,0250
PA6 Vo 14	14	13,9	18,4	with wire puller	50	0,0317
PA6 Vo 17	17	16,3	21,4	with wire puller	50	0,0384
PA6 Vo 19	19	19,2	24,1	with wire puller	50	0,0510
PA6 Vo 22	22	21,5	25,4	with wire puller	50	0,0567
PA6 Vo 23	23	22,8	28,7	with wire puller	50	0,0588
PA6 Vo 26	26	25,7	31	with wire puller	50	0,0406
PA6 Vo 29	29	28,6	34,5	with wire puller	25	0,0483
PA6 Vo 36	36	35,7	42,5	with wire puller	25	0,0714
PA6 Vo 48	48	47,2	54,4	with wire puller	25	0,0840

Technical Features

Material	PA6 Polyamid-HF
Compression Resistance	750 Newton / 60 Sec Class 3
Impact Resistance	2 Kg / 100 mm Class 3
Temperature Resistance	-40 C/ +60C
Permanent Vibration	as per DIN 55442, high flexibility
Flame Retardant	V-DIN 75200-HF Vo according to UL94 DIN EN ISO 8580

Technical Features

Material	PA6 Polyamid-HF
Compression Resistance	750 Newton / 60 Sec Class 3
Impact Resistance	2 Kg / 100 mm Class 3
Temperature Resistance	-40 C/ +60C
Permanent Vibration	as per DIN 55442, high flexibility
Flame Retardant	V-DIN 75200-HF Vo according to UL94 DIN EN ISO 8580



Spiral Pipes



MTK
MADE IN TURKEY

Polyamid PA6 Connecting Components of Spiral Pipes PG Type

PA6 PG Rakor (Somunlu) - Муфта труба-коробка (PG)

Mounting to Pipe



RPG

Model Number	Product Description	Suitable Size mm	Inside "C" mm	Ø "D" mm
RPG 7	PG Connector	7	10,1	11
RPG 8,5	PG Connector	8,5	12	11
RPG 10	PG Connector	10	13,6	13,6
RPG 12	PG Connector	12	16,2	16,2
RPG 14	PG Connector	14	18,8	18,8
RPG 17	PG Connector	17	22	22
RPG 22	PG Connector	22	29	29
RPG 29	PG Connector	29	35	35
RPG 36	PG Connector	36	43	43
RPG 48	PG Connector	48	55	55

RPG

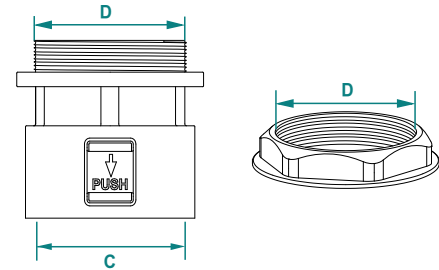

PA6 PG Rakor (Somunlu) - Муфта труба-коробка (PG)

Polyamid PA6 Connecting Components of Spiral Pipes Metric Type

PA6 Metric Rakor (Somunlu) - Муфта труба-коробка

Mounting to Pipe



RM

Model Number	Product Description	Inside "C" mm	Ø "D" mm
RM 7	Metric Connector	10,1	8,5
RM 8,5	Metric Connector	12	10,4
RM 10	Metric Connector	13,6	14
RM 12	Metric Connector	16,2	14
RM 14	Metric Connector	18,8	17,5
RM 17	Metric Connector	22	17,5
RM 22	Metric Connector	29	22,4
RM 29	Metric Connector	35	29,4
RM 36	Metric Connector	43	37,5
RM 48	Metric Connector	55	48,5

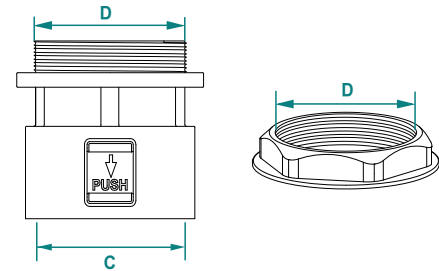

PA6 Metric Rakor (Somunlu) - Муфта труба-коробка

Polyamid PA6 Clip for Spiral Pipes

PA6 Klips Karakli- Держатель с крышкой

Mounting to Pipe



CL

Model Number	Product Description	Suitable Size mm	L X H mm	Ø "D" mm
CL 7	Clip	7/8,5	15x13	7
CL 10	Clip	10	18x15	9
CL 12	Clip	12	20x17	10
CL 14	Clip	14	23x19	11
CL 17	Clip	17	27x22,5	14
CL 22	Clip	22/23	34x29	22
CL 29	Clip	29	41x35	25
CL 36	Clip	36	53x41	31
CL 48	Clip	48	81x62	51

CL

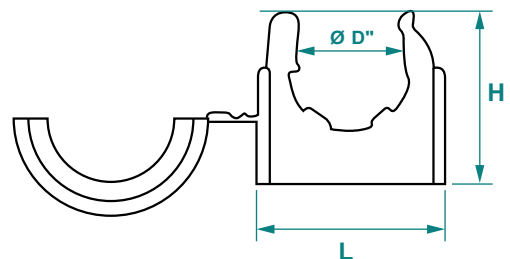

PVC Rigid Pipes Flame-retardant Cold Bendable Light Duty (320 newton)

PVC Düz Boru Alev Yaumayan Hafif Seri (320 newton) - Жесткая гладкостенная труба из ПВХ (легкая серия)



Standard Color

Light Grey:
RAL:7035

Açık Gri

SR1 3...

Model Number	Nominal Diameter	Inside D mm	Outside D mm	Length mt	Packaging mt	Package Volume m ³
SR1 316	Ø 16	13,7	16	3	102	0,0261
SR1 320	Ø 20	17,6	20	3	102	0,0408
SR1 325	Ø 25	22,2	25	3	75	0,0469
SR1 332	Ø 32	28,7	32	3	51	0,0522
SR1 340	Ø 40	36,5	40	3	51	0,0816
SR1 350	Ø 50	46,4	50	3	30	0,0750

PVC Rigid Pipes Flame-retardant Cold Bendable Medium Duty (750 newton)

PVC Düz Boru Alev Yaumayan Orta Seri (750 newton) - Жесткая гладкостенная труба из ПВХ (средняя серия)



Standard Color

Light Grey:
RAL:7035

Açık Gri

SR2 3...

Model Number	Nominal Diameter	Inside D mm	Outside D mm	Length mt	Packaging mt	Package Volume m ³
SR2 316	Ø 16	13,2	16	3	102	0,0261
SR2 320	Ø 20	17,1	20	3	102	0,0408
SR2 325	Ø 25	21,6	25	3	75	0,0469
SR2 332	Ø 32	28	32	3	51	0,0522
SR2 340	Ø 40	35,8	40	3	51	0,0816
SR2 350	Ø 50	45,7	50	3	30	0,0750

PVC Rigid Pipes Flame-retardant Cold Bendable Heavy Duty (1250 newton)

PVC Düz Boru Alev Yaumayan Ağır Seri (1250 newton) - Жесткая гладкостенная труба из ПВХ (тяжелая серия)



Standard Color

Grey:
RAL:7035

SR3 3...

Model Number	Nominal Diameter	Inside D mm	Outside D mm	Length mt	Packaging mt	Package Volume m ³
SR3 316	Ø 16	12	16	3	102	0,0261
SR3 320	Ø 20	15,8	20	3	102	0,0408
SR3 325	Ø 25	20,6	25	3	75	0,0469
SR3 332	Ø 32	26,9	32	3	51	0,0522
SR3 340	Ø 40	34,5	40	3	51	0,0816
SR3 350	Ø 50	44,2	50	3	30	0,0750

Technical Features

Material	PVC Base Thermoplastic
Compression Resistance	320 Newton / 60 Sec Class 2
Impact Resistance	1 Kg / 100 mm / -25 C Class 2
Temperature Resistance	-25 C / +60C Class 4/1
Insulation Strength	2000 V / 50 Hz / 15 Min

Other color options



Beyaz

White
RAL:9003

Prod. Code	Size
SR1 316 B	16
SR1 320 B	20
SR1 325 B	25
SR1 332 B	32
SR1 340 B	40
SR1 350 B	50



Siyah

Black:
RAL:9005

Prod. Code	Size
SR1 316 S	16
SR1 320 S	20
SR1 325 S	25
SR1 332 S	32
SR1 340 S	40
SR1 350 S	50

Technical Features

Material	PVC Base Thermoplastic
Compression Resistance	750 Newton / 60 Sec Class 3
Impact Resistance	1 Kg / 100 mm / -25 C Class 2

Other color options



Beyaz

White
RAL:9003

Prod. Code	Size
SR2 316 B	16
SR2 320 B	20
SR2 325 B	25
SR2 332 B	32
SR2 340 B	40
SR2 350 B	50



Siyah

Black:
RAL:7035

Prod. Code	Size
SR2 316 S	16
SR2 320 S	20
SR2 325 S	25
SR2 332 S	32
SR2 340 S	40
SR2 350 S	50

Technical Features

Material	PVC Base Thermoplastic
Compression Resistance	1250 Newton / 60 Sec Class 4
Impact Resistance	2 Kg / 100 mm / -25 C Class 3

Other color options



Beyaz

White
RAL:9003

Prod. Code	Size
SR3 316 B	16
SR3 320 B	20
SR3 325 B	25
SR3 332 B	32
SR3 340 B	40
SR3 350 B	50



Siyah

Black:
RAL:7035

Prod. Code	Size
SR3 316 S	16
SR3 320 S	20
SR3 325 S	25
SR3 332 S	32
SR3 340 S	40
SR3 350 S	50



PVC Rigid Pipes



PVC Rigid Pipes With Coupling Flame-retardant Cold Bendable / Light Guage

PVC Muflu Düz Boru Alev Yayımayan Hafif Seri (320 newton) - Жесткая гладкостенная труба из ПВХ (легкая серия)



Standard Color

Light Grey:
RAL:7035

Açık Gri

SR1 3... MF

Model Number	Nominal Diameter	Inside D mm	Outside D mm	Length mt	Packaging mt	Package Volume m ³
SR1 316 MF	Ø 16	13,7	16	3	102	0,0261
SR1 320 MF	Ø 20	17,6	20	3	102	0,0408
SR1 325 MF	Ø 25	22,2	25	3	75	0,0469
SR1 332 MF	Ø 32	28,7	32	3	51	0,0522
SR1 340 MF	Ø 40	36,5	40	3	51	0,0816
SR1 350 MF	Ø 50	46,4	50	3	30	0,0750

PVC Rigid Pipes With Coupling Flame-retardant Cold Bendable / Medium Guage

PVC Muflu Düz Boru Alev Yayımayan Orta Seri (750 newton) - Жесткая гладкостенная труба из ПВХ (средняя серия)



Standard Color

Light Grey:
RAL:7035

Açık Gri

SR2 3... MF

Model Number	Nominal Diameter	Inside D mm	Outside D mm	Length mt	Packaging mt	Package Volume m ³
SR2 316 MF	Ø 16	13,2	16	3	102	0,0261
SR2 320 MF	Ø 20	17,1	20	3	102	0,0408
SR2 325 MF	Ø 25	21,6	25	3	75	0,0469
SR2 332 MF	Ø 32	28	32	3	51	0,0522
SR2 340 MF	Ø 40	35,8	40	3	51	0,0816
SR2 350 MF	Ø 50	45,7	50	3	30	0,0750

PVC Rigid Pipes With Coupling Flame-retardant Cold Bendable / Heavy Guage

PVC Muflu Düz Boru Alev Yayımayan Ağır Seri (750 newton) - Жесткая гладкостенная труба из ПВХ (средняя серия)



Standard Color

Light Grey:
RAL:7035

Açık Gri

SR3 3... MF

Model Number	Nominal Diameter	Inside D mm	Outside D mm	Length mt	Packaging mt	Package Volume m ³
SR3 316 MF	Ø 16	12	16	3	102	0,0261
SR3 320 MF	Ø 20	15,8	20	3	102	0,0408
SR3 325 MF	Ø 25	20,6	25	3	75	0,0469
SR3 332 MF	Ø 32	26,9	32	3	51	0,0522
SR3 340 MF	Ø 40	34,5	40	3	51	0,0816
SR3 350 MF	Ø 50	44,2	50	3	30	0,0750

Technical Features

Material	PVC Base Thermoplastic
Compression Resistance	320 Newton / 60 Sec Class 2
Impact Resistance	1 Kg / 100 mm / -25 C Class 2
Temperature Resistance	-25 C / +60C Class 4/1
Insulation Strength	2000 V / 50 Hz / 15 Min
Insulation Resistance	>100 MΩ / 60 sec / 500 V

Other color options



RAL:9003 Beyaz



RAL:9005 Siyah

Prod. Code	Size
SR1 316 BMF	16
SR1 320 BMF	20
SR1 325 BMF	25
SR1 332 BMF	32
SR1 340 BMF	40
SR1 350 BMF	50

Prod. Code	Size
SR1 316 SMF	16
SR1 320 SMF	20
SR1 325 SMF	25
SR1 332 SMF	32
SR1 340 SMF	40
SR1 350 SMF	50

Technical Features

Material	PVC Base Thermoplastic
Compression Resistance	750 Newton / 60 Sec Class 3
Impact Resistance	1 Kg / 100 mm / -25 C Class 2

Other color options



Beyaz



Siyah

White RAL:9003

Black: RAL:9005

Prod. Code	Size
SR2 316 BMF	16
SR2 320 BMF	20
SR2 325 BMF	25
SR2 332 BMF	32
SR2 340 BMF	40
SR2 350 BMF	50

Prod. Code	Size
SR2 316 SMF	16
SR2 320 SMF	20
SR2 325 SMF	25
SR2 332 SMF	32
SR2 340 SMF	40
SR2 350 SMF	50

Technical Features

Material	PVC Base Thermoplastic
Compression Resistance	1250 Newton / 60 Sec Class 4
Impact Resistance	2 Kg / 100 mm / -25 C Class 3

Other color options



Beyaz



Siyah

White RAL:9003

Black: RAL:9005

Prod. Code	Size
SR1 316 BMF	16
SR1 320 BMF	20
SR1 325 BMF	25
SR1 332 BMF	32
SR1 340 BMF	40
SR1 350 BMF	50

Prod. Code	Size
SR1 316 SMF	16
SR1 320 SMF	20
SR1 325 SMF	25
SR1 332 SMF	32
SR1 340 SMF	40
SR1 350 SMF	50

PE Rigit Pipes Halogen Free / Light Guage

PE Düz Boru Alev Yaymayan Hafif Seri (320 newton) - Жесткая гладкостенная труба из ПВХ (легкая серия)



Standard Color

Light Grey: RAL:7035

Açık Gri

SD1 3...

Model Number	Nominal Diameter	Inside D mm	Outside D mm	Length mt	Packaging mt	Package Volume m ³
SD1 316	Ø 16	13,7	16	3	102	0,0261
SD1 320	Ø 20	17,6	20	3	102	0,0408
SD1 325	Ø 25	22,2	25	3	75	0,0469
SD1 332	Ø 32	28,7	32	3	51	0,0522

PE Rigit Pipes Halogen Free / Heavy Guage

PE Düz Boru Alev Yaymayan Ağır Seri (750 newton) - Жесткая гладкостенная труба из ПВХ (тяжелая серия)



Standard Color

Light Grey: RAL:7035

Açık Gri

SD3 3...

Model Number	Nominal Diameter	Inside D mm	Outside D mm	Length mt	Packaging mt	Package Volume m ³
SD3 316	Ø 16	12	16	3	102	0,0261
SD3 320	Ø 20	15,8	20	3	102	0,0408
SD3 325	Ø 25	20,6	25	3	75	0,0469
SD3 332	Ø 32	26,9	32	3	51	0,0522

Technical Features

Material	PE Base Thermoplastic
Compression Resistance	320 Newton / 60 Sec Class 2
Impact Resistance	2 Kg / 100 mm / -25 C Class 3
Temperature Resistance	-25 C / +60C Class 4/1
Insulation Strength	2000 V / 50 Hz / 15 Min
Insulation Resistance	>100 MΩ / 60 sec / 500 V
Color Code	RAL 9003

Other color options



Beyaz

White RAL:9003

Prod. Code	Size
SD1 316 B	16
SD1 320 B	20
SD1 325 B	25
SD1 332 B	32

Technical Features

Material	PE Base Thermoplastic
Compression Resistance	750 Newton / 60 Sec Class 3
Impact Resistance	2 Kg / 100 mm / -25 C Class 3
Temperature Resistance	-25 C / +60C Class 4/1
Insulation Strength	2000 V / 50 Hz / 15 Min
Insulation Resistance	>100 MΩ / 60 sec / 500 V
Color Code	RAL 9003

Other color options



Beyaz

White RAL:9003

Prod. Code	Size
SD3 316 B	16
SD3 320 B	20
SD3 325 B	25
SD3 332 B	32



PP Rigit Pipes



PP Rigit Pipes Halogen Free Flame-retardant Light Gauge (320 newton)

PP Düz Boru Halogen Free ve Alev Yaumayan Hafif Serisi - Жесткая гладкостенная труба из ПНД без галогенов, не распространяет горение (легкая серия)



Standard Color

Light Grey:
RAL:7035

Açık Gri

SF1 3...

Model Number	Nominal Diameter	Inside D mm	Outside D mm	Length mt	Packaging mt	Package Volume m ³
SF1 316	Ø 16	13,7	16	3	102	0,0261
SF1 320	Ø 20	17,6	20	3	102	0,0408
SF1 325	Ø 25	22,2	25	3	75	0,0469
SF1 332	Ø 32	28,7	32	3	51	0,0522
SF1 340	Ø 40	36,5	40	3	51	0,0816
SF1 350	Ø 50	46,4	50	3	30	0,0750

Technical Features

Material	PP Base Thermoplastic
Compression Resistance	320 Newton / 60 Sec Class 2
Impact Resistance	2 Kg / 100 mm / -25 C Class 3
Temperature Resistance	-25 C / +60C Class 4/1
Insulation Strength	2000 V / 50 Hz / 15 Min
Insulation Resistance	>100 MΩ / 60 sec / 500 V

Other color options



Beyaz

White
RAL:9003

Siyah

Black
RAL:7035

Prod. Code	Size
SF1 316 B	16
SF1 320 B	20
SF1 325 B	25
SF1 332 B	32
SF1 340 B	40
SF1 350 B	50

Prod. Code	Size
SF1 316 S	16
SF1 320 S	20
SF1 325 S	25
SF1 332 S	32
SF1 340 S	40
SF1 350 S	50

PP Rigit Pipes Halogen Free Flame-retardant Heavy Gauge (750 newton)

PP Düz Boru Halogen Free ve Alev Yaumayan Ağır Serisi - Жесткая гладкостенная труба из ПНД без галогенов, не распространяет горение (тяжелая серия)

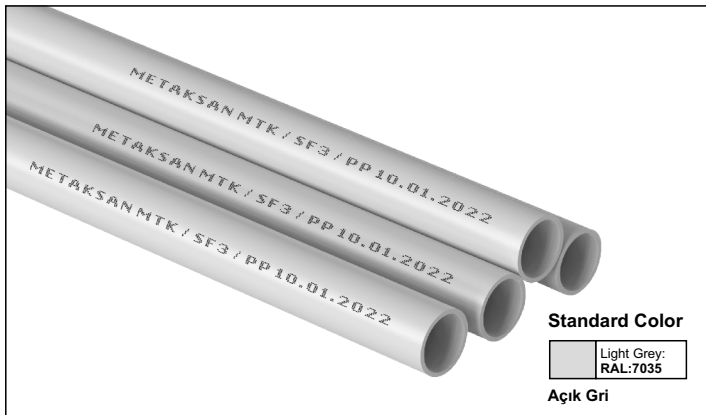

Standard Color

Light Grey:
RAL:7035

Açık Gri

SF3 3...

Model Number	Nominal Diameter	Inside D mm	Outside D mm	Length mt	Packaging mt	Package Volume m ³
SF3 316	Ø 16	12	16	3	102	0,0261
SF3 320	Ø 20	15,8	20	3	102	0,0408
SF3 325	Ø 25	20,6	25	3	75	0,0469
SF3 332	Ø 32	26,9	32	3	51	0,0522
SF3 340	Ø 40	34,5	40	3	51	0,0816
SF3 350	Ø 50	44,2	50	3	30	0,0750

Technical Features

Material	PP Base Thermoplastic
Compression Resistance	750 Newton / 60 Sec Class 2
Impact Resistance	2 Kg / 100 mm / -25 C Class 2
Temperature Resistance	-25 C / +60C Class 4/1
Insulation Strength	2000 V / 50 Hz / 15 Min
Insulation Resistance	>100 MΩ / 60 sec / 500 V

Other color options



Beyaz

White
RAL:9003

Siyah

Black
RAL:7035

Prod. Code	Size
SF3 316 B	16
SF3 320 B	20
SF3 325 B	25
SF3 332 B	32
SF3 340 B	40
SF3 350 B	50

Prod. Code	Size
SF3 316 S	16
SF3 320 S	20
SF3 325 S	25
SF3 332 S	32
SF3 340 S	40
SF3 350 S	50



PP Rigit Pipes with coupling Halogen Free Flame-retardant / Light Gauge

PP Muflu Düz Boru Alev Yağmayan Hafif Seri (320 newton) - Жесткая гладкостенная труба из ПНД без галогенов, не распространяет горение (легкая серия)

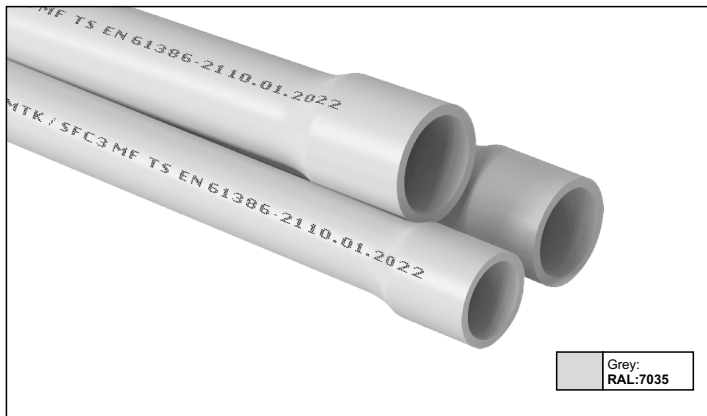

Grey:
RAL:7035

SF1 3... MF

Model Number	Nominal Diameter	Inside D mm	Outside D mm	Length mt	Packaging mt	Package Volume m ³
SF1 316 MF	Ø 16	13,7	16	3	102	0,0261
SF1 320 MF	Ø 20	17,6	20	3	102	0,0408
SF1 325 MF	Ø 25	22,2	25	3	75	0,0469
SF1 332 MF	Ø 32	28,7	32	3	51	0,0522
SF1 340 MF	Ø 40	36,5	40	3	51	0,0816
SF1 350 MF	Ø 50	46,4	50	3	30	0,0750

Technical Features

Material	PP Base Thermoplastic
Compression Resistance	320 Newton / 60 Sec Class 2
Impact Resistance	2 Kg / 100 mm / -25 C Class 3
Temperature Resistance	-25 C / +60C Class 4/1
Insulation Strength	2000 V / 50 Hz / 15 Min
Insulation Resistance	>100 MΩ / 60 sec / 500 V

Other color options



Beyaz

White
RAL:9003

Siyah

Black:
RAL:7035

Prod. Code	Size
SF1 316 BMF	16
SF1 320 BMF	20
SF1 325 BMF	25
SF1 332 BMF	32
SF1 340 BMF	40
SF1 350 BMF	50

Prod. Code	Size
SF1 316 SMF	16
SF1 320 SMF	20
SF1 325 SMF	25
SF1 332 SMF	32
SF1 340 SMF	40
SF1 350 SMF	50

PP Rigit Pipes with coupling Halogen Free Flame-retardant / Heavy Gauge

PP Muflu Düz Boru Alev Yağmayan Ağır Seri (750 newton) - Жесткая гладкостенная труба из ПВХ (тяжелая серия)

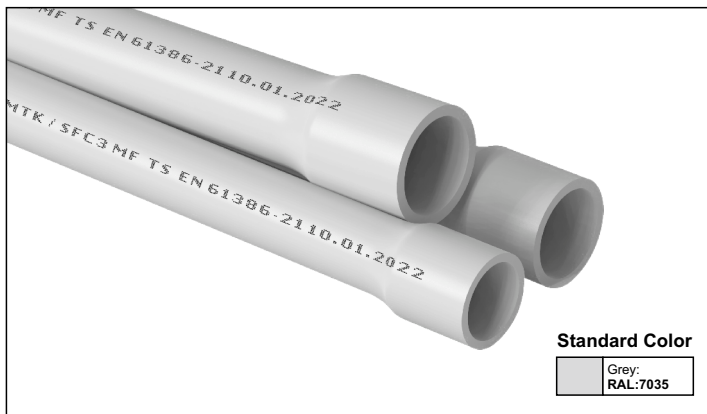

Standard Color

Grey:
RAL:7035

SF3 3... MF

Model Number	Nominal Diameter	Inside D mm	Outside D mm	Length mt	Packaging mt	Package Volume m ³
SF3 316 MF	Ø 16	12	16	3	102	0,0261
SF3 320 MF	Ø 20	15,8	20	3	102	0,0408
SF3 325 MF	Ø 25	20,6	25	3	75	0,0469
SF3 332 MF	Ø 32	26,9	32	3	51	0,0522
SF3 340 MF	Ø 40	34,5	40	3	51	0,0816
SF3 350 MF	Ø 50	44,2	50	3	30	0,0750

Technical Features

Material	PP Base Thermoplastic
Compression Resistance	750 Newton / 60 Sec Class 2
Impact Resistance	2 Kg / 100 mm / -25 C Class 2
Temperature Resistance	-25 C / +60C Class 4/1
Insulation Strength	2000 V / 50 Hz / 15 Min
Insulation Resistance	>100 MΩ / 60 sec / 500 V

Other color options



Beyaz

White
RAL:9003

Siyah

Black:
RAL:7035

Prod. Code	Size
SF3 316 BMF	16
SF3 320 BMF	20
SF3 325 BMF	25
SF3 332 BMF	32
SF3 340 BMF	40
SF3 350 BMF	50

Prod. Code	Size
SF3 316 SMF	16
SF3 320 SMF	20
SF3 325 SMF	25
SF3 332 SMF	32
SF3 340 SMF	40
SF3 350 SMF	50

PE Coiled Pipe - Light Series – Halogen Free - 320 Newton

PE Kangal Boru Hafif Seri – 320 Newton - Полиэтиленовая труба в бухте, лёгкая серия – 320 Ньютон

Without Wire Puller

Kilavuz Telsiz



Standard Color

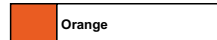

Turuncu

SP1 0...

Product Code	Size mm	Inside D mm	Outside D mm	Puller	Standard Color	Package mt
SP1 014	14	11,5	14	without puller	Orange	200
SP1 016	16	13,2	16	without puller	Orange	200
SP1 018	18	15,0	18	without puller	Orange	200
SP1 020	20	17,1	20	without puller	Orange	200
SP1 025	25	21,4	25	without puller	Orange	100
SP1 032	25	27,8	32	without puller	Orange	100
SP1 040	25	35,0	40	without puller	Orange	100
SP1 050	25	44,4	50	without puller	Orange	100
SP1 063	25	57,0	63	without puller	Orange	100
SP1 075	25	68,2	75	without puller	Orange	100
SP1 090	25	82,4	90	without puller	Orange	100

APPLICATION FIELDS

Used in flush mounted and surface mounted applications, walls and suspended ceilings, under plaster and electrical installations where low mechanical stress is expected.

PE Coiled Pipe - Light Series – Halogen Free - 320 Newton

PE Kangal Boru Hafif Seri – 320 Newton - Полиэтиленовая труба в бухте, лёгкая серия – 320 Ньютон

With Wire Puller



Standard Color

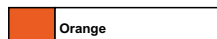

Turuncu

SP1 1...

Product Code	Size mm	Inside D mm	Outside D mm	Puller	Standard Color	Package mt
SP1 114	14	11,5	14	with wire puller	Orange	200
SP1 116	16	13,2	16	with wire puller	Orange	200
SP1 118	18	15,0	18	with wire puller	Orange	200
SP1 120	20	17,1	20	with wire puller	Orange	200
SP1 125	25	21,4	25	with wire puller	Orange	100
SP1 132	25	27,8	32	with wire puller	Orange	100
SP1 140	25	35,0	40	with wire puller	Orange	100
SP1 150	25	44,4	50	with wire puller	Orange	100
SP1 163	25	57,0	63	with wire puller	Orange	100
SP1 175	25	68,2	75	with wire puller	Orange	100
SP1 190	25	82,4	90	with wire puller	Orange	100

Technical Features

Material	PP Base Thermoplastic
Compression Resistance	320 Newton / 60 Sec Class 2
Impact Resistance	2 Kg / 100 mm / -25 C Class 3
Temperature Resistance	-25 C / +60C Class 4/1
Insulation Strength	2000 V / 50 Hz / 15 Min
Insulation Resistance	>100 MΩ / 60 sec / 500 V

Other color options



Product Code	Size mm	Product Code	Size mm	Product Code	Size mm
SP1 014 M	14	SP1 014 S	14	SP1 014 G	14
SP1 016 M	16	SP1 016 S	16	SP1 016 G	16
SP1 018 M	18	SP1 018 S	18	SP1 018 G	18
SP1 020 M	20	SP1 020 S	20	SP1 020 G	20
SP1 025 M	25	SP1 025 S	25	SP1 025 G	25
SP1 032 M	32	SP1 032 S	32	SP1 032 G	32
SP1 040 M	40	SP1 040 S	40	SP1 040 G	40
SP1 050 M	50	SP1 050 S	50	SP1 050 G	50
SP1 063 M	63	SP1 063 S	63	SP1 063 G	63
SP1 075 M	75	SP1 075 S	75	SP1 075 G	75
SP1 090 M	90	SP1 090 S	90	SP1 090 G	90



Technical Features

Material	PP Base Thermoplastic
Compression Resistance	320 Newton / 60 Sec Class 2
Impact Resistance	2 Kg / 100 mm / -25 C Class 3
Temperature Resistance	-25 C / +60C Class 4/1
Insulation Strength	2000 V / 50 Hz / 15 Min
Insulation Resistance	>100 MΩ / 60 sec / 500 V

Other color options



Product Code	Size mm	Product Code	Size mm	Product Code	Size mm
SP1 114 M	14	SP1 114 S	14	SP1 114 G	14
SP1 116 M	16	SP1 116 S	16	SP1 116 G	16
SP1 118 M	18	SP1 118 S	18	SP1 118 G	18
SP1 120 M	20	SP1 120 S	20	SP1 120 G	20
SP1 125 M	25	SP1 125 S	25	SP1 125 G	25
SP1 132 M	32	SP1 132 S	32	SP1 132 G	32
SP1 140 M	40	SP1 140 S	40	SP1 140 G	40
SP1 150 M	50	SP1 150 S	50	SP1 150 G	50
SP1 163 M	63	SP1 163 S	63	SP1 163 G	63
SP1 175 M	75	SP1 175 S	75	SP1 175 G	75
SP1 190 M	90	SP1 190 S	90	SP1 190 G	90

PE Coiled Pipe - Heavy Series – 750 Newton

PE Kangal Boru Ağır Seri – 750 Newton - Полиэтиленовая труба в бухте – Тяжёлая серия – 750 Ньютон

Without Wire Puller

Kilavuz Telsiz



APPLICATION FIELDS

Used in flush mounted and surface mounted applications, walls and suspended ceilings, under plaster and electrical installations where low mechanical stress is expected.

Standard Color

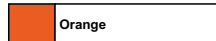

SP3 0...

Product Code	Size mm	Inside D mm	Outside D mm	Puller	Standard Color	Package mt
SP3 014	14	11,0	14	without puller	Orange	200
SP3 016	16	12,4	16	without puller	Orange	200
SP3 018	18	14,0	18	without puller	Orange	200
SP3 020	20	16,0	20	without puller	Orange	200
SP3 025	25	20,0	25	without puller	Orange	100
SP3 032	32	25,4	32	without puller	Orange	100
SP3 040	40	32,6	40	without puller	Orange	100
SP3 050	50	42,0	50	without puller	Orange	100
SP3 063	63	54,4	63	without puller	Orange	100
SP3 075	75	65,6	75	without puller	Orange	100
SP3 090	90	79,6	90	without puller	Orange	50

PE Coiled Pipe - Heavy Series – 750 Newton

PE Kangal Boru Ağır Seri – 750 Newton - Полиэтиленовая труба в бухте – Тяжёлая серия – 750 Ньютон

With Wire Puller



With Wire Puller



APPLICATION FIELDS

Used in flush mounted and surface mounted applications, walls and suspended ceilings, under plaster and electrical installations where low mechanical stress is expected.

Standard Color

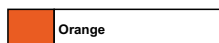

Turuncu

SP3 1...

Product Code	Size mm	Inside D mm	Outside D mm	Puller	Standard Color	Package mt
SP3 114	14	11,0	14	without puller	Orange	200
SP3 116	16	12,4	16	without puller	Orange	200
SP3 118	18	14,0	18	without puller	Orange	200
SP3 120	20	16,0	20	without puller	Orange	200
SP3 125	25	20,0	25	without puller	Orange	100
SP3 132	32	25,4	32	without puller	Orange	100
SP3 140	40	32,6	40	without puller	Orange	100
SP3 150	50	42,0	50	without puller	Orange	100
SP3 163	63	54,4	63	without puller	Orange	100
SP3 175	75	65,6	75	without puller	Orange	100
SP3 190	90	79,6	90	without puller	Orange	50

Technical Features

Material	PP Base Thermoplastic
Compression Resistance	750 Newton / 60 Sec Class 3
Impact Resistance	2 Kg / 100 mm / -25 C Class 3
Temperature Resistance	-25 C / +60C Class 4/1
Insulation Strength	2000 V / 50 Hz / 15 Min
Insulation Resistance	>100 MΩ / 60 sec / 500 V

Other color options



Product Code	Size mm
SP3 014 M	14
SP3 016 M	16
SP3 018 M	18
SP3 020 M	20
SP3 025 M	25
SP3 032 M	32
SP3 040 M	40
SP3 050 M	50
SP3 063 M	63
SP3 075 M	75
SP3 090 M	90

Product Code	Size mm
SP3 014 S	14
SP3 016 S	16
SP3 018 S	18
SP3 020 S	20
SP3 025 S	25
SP3 032 S	32
SP3 040 S	40
SP3 050 S	50
SP3 063 S	63
SP3 075 S	75
SP3 090 S	90

Product Code	Size mm
SP3 014 G	14
SP3 016 G	16
SP3 018 G	18
SP3 020 G	20
SP3 025 G	25
SP3 032 G	32
SP3 040 G	40
SP3 050 G	50
SP3 063 G	63
SP3 075 G	75
SP3 090 G	90



Technical Features

Material	PP Base Thermoplastic
Compression Resistance	320 Newton / 60 Sec Class 2
Impact Resistance	2 Kg / 100 mm / -25 C Class 3
Temperature Resistance	-25 C / +60C Class 4/1
Insulation Strength	2000 V / 50 Hz / 15 Min
Insulation Resistance	>100 MΩ / 60 sec / 500 V

Other color options



Product Code	Size mm
SP3 114 M	14
SP3 116 M	16
SP3 118 M	18
SP3 120 M	20
SP3 125 M	25
SP3 132 M	32
SP3 140 M	40
SP3 150 M	50
SP3 163 M	63
SP3 175 M	75
SP3 190 M	90

Product Code	Size mm
SP3 114 S	14
SP3 116 S	16
SP3 118 S	18
SP3 120 S	20
SP3 125 S	25
SP3 132 S	32
SP3 140 S	40
SP3 150 S	50
SP3 163 S	63
SP3 175 S	75
SP3 190 S	90

Product Code	Size mm
SP3 114 G	14
SP3 116 G	16
SP3 118 G	18
SP3 120 G	20
SP3 125 G	25
SP3 132 G	32
SP3 140 G	40
SP3 150 G	50
SP3 163 G	63
SP3 175 G	75
SP3 190 G	90



PE Coil Pipes



PE Coiled Pipe - Light Series – Halogen Free - Flame Retardant - 320 Newton

PE Kangal Boru Hafif Seri – 320 Newton - Alev Yayımayan - Полиэтиленовая труба в бухте, лёгкая серия – 320 Ньютон

Without Wire Puller

Kilavuz Telsiz



Standard Color

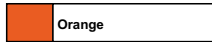

Turuncu

Technical Features

Material	PP Base Thermoplastic
Compression Resistance	320 Newton / 60 Sec Class 2
Impact Resistance	2 Kg / 100 mm / -25 C Class 3
Temperature Resistance	-25 C / +60C Class 4/1
Insulation Strength	2000 V / 50 Hz / 15 Min
Insulation Resistance	>100 MΩ / 60 sec / 500 V

SH1 0...

Product Code	Size mm	Inside D mm	Outside D mm	Puller	Standard Color	Package mt
SH1 014	14	11,5	14	without puller	Orange	200
SH1 016	16	13,2	16	without puller	Orange	200
SH1 018	18	15,0	18	without puller	Orange	200
SH1 020	20	17,1	20	without puller	Orange	200
SH1 025	25	21,4	25	without puller	Orange	100
SH1 032	32	27,8	32	without puller	Orange	100
SH1 040	40	35,0	40	without puller	Orange	100
SH1 050	50	44,4	50	without puller	Orange	100
SH1 063	63	57,0	63	without puller	Orange	100
SH1 075	75	68,2	75	without puller	Orange	100
SH1 090	90	82,4	90	without puller	Orange	50

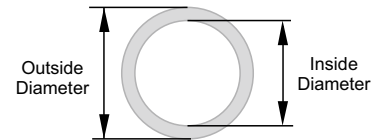

APPLICATION FIELDS

Used in flush mounted and surface mounted applications, walls and suspended ceilings, under plaster and electrical installations where low mechanical stress is expected.



PE Coiled Pipe - Light Series – Halogen Free - Flame Retardant 320 Newton

PE Kangal Boru Hafif Seri – 320 Newton - Полиэтиленовая труба в бухте, лёгкая серия – 320 Ньютон

With Wire Puller



Standard Color

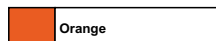

Turuncu

Technical Features

Material	PP Base Thermoplastic
Compression Resistance	320 Newton / 60 Sec Class 2
Impact Resistance	2 Kg / 100 mm / -25 C Class 3
Temperature Resistance	-25 C / +60C Class 4/1
Insulation Strength	2000 V / 50 Hz / 15 Min
Insulation Resistance	>100 MΩ / 60 sec / 500 V

Other color options

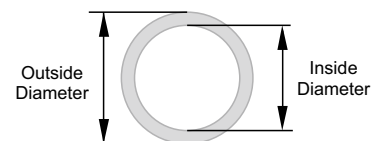

APPLICATION FIELDS

Used in flush mounted and surface mounted applications, walls and suspended ceilings, under plaster and electrical installations where low mechanical stress is expected.

SH1 1...

Product Code	Size mm	Inside D mm	Outside D mm	Puller	Standard Color	Package mt
SH1 114	14	11,5	14	with wire puller	Orange	200
SH1 116	16	13,2	16	with wire puller	Orange	200
SH1 118	18	15,0	18	with wire puller	Orange	200
SH1 120	20	17,1	20	with wire puller	Orange	200
SH1 125	25	21,4	25	with wire puller	Orange	100
SH1 132	32	27,8	32	with wire puller	Orange	100
SH1 140	40	35,0	40	with wire puller	Orange	100
SH1 150	50	44,4	50	with wire puller	Orange	100
SH1 163	63	57,0	63	with wire puller	Orange	100
SH1 175	75	68,2	75	with wire puller	Orange	100
SH1 190	90	82,4	90	with wire puller	Orange	50

Flexible Double Walled Corrugated Pipes

Esnek Çift Cidarlı Koruage Borular - Гибкие двухслойные гофрированные трубы



With Wire Puller

Kılavuz Telli

Standard Color



Kırmızı

Product Code	Size mm	Inside D mm	Outside D mm	Puller	Standard Color	Package mt
STB 050	50	40	50	with puller	Red	50
STB 075	75	62	75	with puller	Red	50
STB 090	90	75	90	with puller	Red	50
STB 110	110	100	110	with puller	Red	25

Technical Features	
Material	HDPE (High Density Polyethylene)
Compression Resistance	450 N / 750 N (EN 61386-24)
Impact Resistance	Normal / Heavy Duty
Temperature Resistance	-25°C / +60°C
Insulation Strength	≥ 100 MΩ
Insulation Resistance	≥ 1000 V
Halogen Free	Yes
IP Protection Class	IP44 / IP54 (with fitting)
Standard	EN 61386-24



Mavi

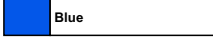

Product Code	Size mm
STB 050 M	50
STB 075 M	75
STB 090 M	90
STB 110 M	110



Siyah



Product Code	Size mm
STB 050 S	50
STB 075 S	75
STB 090 S	90
STB 110 S	110

APPLICATION FIELDS

It is used in energy and telecommunication infrastructure installations and at facilities where the infrastructure systems intensive as cable protection pipes. Flexible double-walled pipes that produced in various lengths, reduces the use of sleeve during installation and provides one piece installation at distances.

Enerji ve Telekomunikasyon altyapı tesisatlarında, kablo koruma borusu olarak altyapı sisteminin yoğun olduğu (havaalanları, fuar alanları, spor tesisleri vb.) tesislerde kullanılır.

Çeşitli uzunluklarda üretilen esnek çiftcidarlı borular kurulum sırasında ek manşon kullanımını azaltarak uzun mesafelerde yekpare kurulum sağlar.

Double-Walled Pipe Muff

Çift Cidarlı Boru Maşonu - Соединительная муфта для двухслойной гофрированной трубы



Product Code	Size mm	Standard Color	Pc mt
STB-051	50	Black	100
STB-076	75	Black	100
STB-091	90	Black	100
STB-120	110	Black	50

PVC Junction Boxes



MTK

PVC Junction Box

PVC Buat - ПВХ распределительная коробка



Açık Gri

Light Grey RAL:7035

RJB

Product Code	Product Explanation	Standard Color
RJB-20-S	PVC Round Junction Box - Ø 20 (Single)	Light Grey / RAL 7035
RJB-20-D	PVC Round Junction Box - Ø 20 (Double)	Light Grey / RAL 7035
RJB-20-L	PVC Round Junction Box - Ø 20 (Double 90 Bend)	Light Grey / RAL 7035
RJB-20-T	PVC Round Junction Box - Ø 20 (Triple)	Light Grey / RAL 7035
RJB-20-Q	PVC Round Junction Box - Ø 20 (Quadruple)	Light Grey / RAL 7035
RJB-25-S	PVC Round Junction Box - Ø 25 (Single)	Light Grey / RAL 7035
RJB-25-D	PVC Round Junction Box - Ø 25 (Double)	Light Grey / RAL 7035
RJB-25-L	PVC Round Junction Box - Ø 25 (Double 90 Bend)	Light Grey / RAL 7035
RJB-25-T	PVC Round Junction Box - Ø 25 (Triple)	Light Grey / RAL 7035
RJB-25-Q	PVC Round Junction Box - Ø 25 (Quadruple)	Light Grey / RAL 7035

Beyaz

White: RAL:9003

RJBI

Product Code	Product Explanation	Optional Color
RJBI-20-S	PVC Round Junction Box - Ø 20 (Single)	White / RAL 9003
RJBI-20-D	PVC Round Junction Box - Ø 20 (Double)	White / RAL 9003
RJBI-20-L	PVC Round Junction Box - Ø 20 (Double 90 Bend)	White / RAL 9003
RJBI-20-T	PVC Round Junction Box - Ø 20 (Triple)	White / RAL 9003
RJBI-20-Q	PVC Round Junction Box - Ø 20 (Quadruple)	White / RAL 9003
RJBI-25-S	PVC Round Junction Box - Ø 25 (Single)	White / RAL 9003
RJBI-25-D	PVC Round Junction Box - Ø 25 (Double)	White / RAL 9003
RJBI-25-L	PVC Round Junction Box - Ø 25 (Double 90 Bend)	White / RAL 9003
RJBI-25-T	PVC Round Junction Box - Ø 25 (Triple)	White / RAL 9003
RJBI-25-Q	PVC Round Junction Box - Ø 25 (Quadruple)	White / RAL 9003

Surface Mounted PVC Junction Boxes

Siva Üstü PVC Buatlar - Накладные ПВХ распределительные коробки

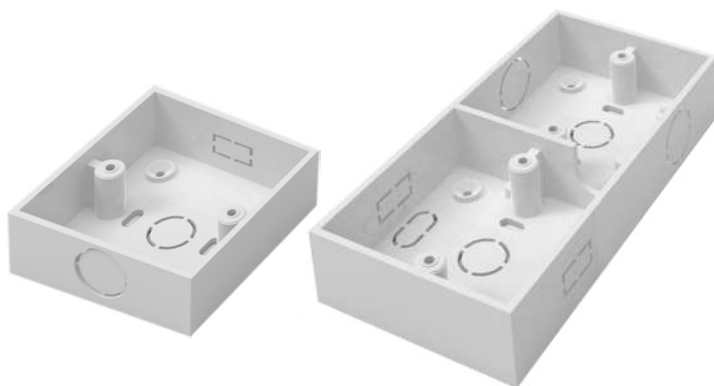

Beyaz

White: RAL:9003

BRB

Product Code	Product Description	Standard Color
BRB S	Surface Mounted PVC Junction Boxes	White / RAL 9003
BRB D	Surface Mounted PVC Junction Boxes	White / RAL 9003

Technical Features

RJB-20-S

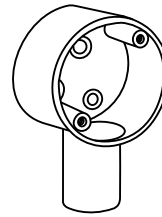

RJB-20-D

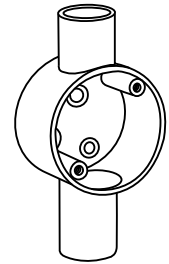

RJB-20-L

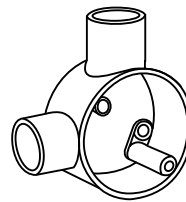

RJB-20-T

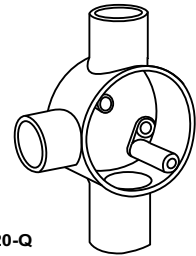

RJB-20-Q

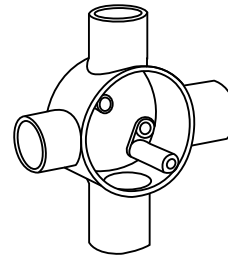

Technical Features

BRB S

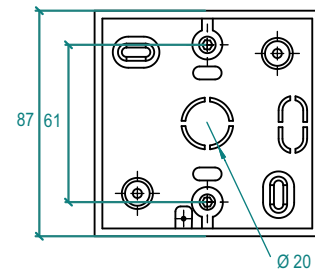

BRB D

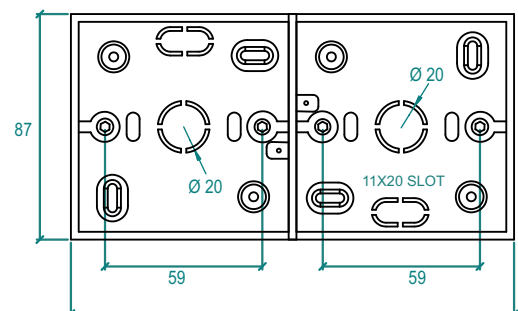
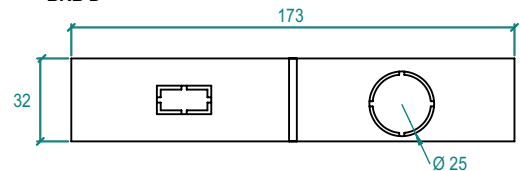



Pipe Fittings



PVC Coupling Flame-retardant

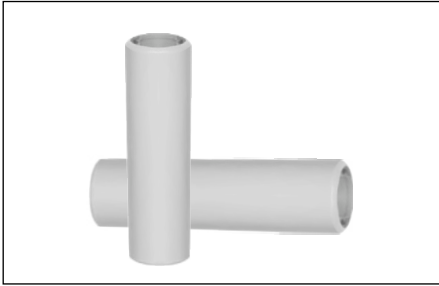

Grey: RAL:7035	White RAL:9003
-------------------	-------------------

GSS				Nominal Diameter	Inside D mm	Outside D,mm	Length mm
PVC Flame-retardant		PP Halogen Free					
Grey: RAL:7035	White RAL:9003	Grey: RAL:7035	White RAL:9003				
GSS-16-PVC	GSS-16-PVC B	GSS-16-PP	GSS-16-PP B	Ø 16	16,1	18,6	80
GSS-20-PVC	GSS-20-PVC B	GSS-20-PP	GSS-20-PP B	Ø 20	20,1	23,0	80
GSS-25-PVC	GSS-25-PVC B	GSS-25-PP	GSS-25-PP B	Ø 25	25,2	28,0	80
GSS-32-PVC	GSS-32-PVC B	GSS-32-PP	GSS-32-PP B	Ø 32	32,2	35,0	100
GSS-40-PVC	GSS-40-PVC B	GSS-40-PP	GSS-40-PP B	Ø 40	40,3	43,0	100
GSS-50-PVC	GSS-50-PVC B	GSS-50-PP	GSS-50-PP B	Ø 50	50,3	53,0	100
GSS-63-PVC	GSS-63-PVC B	GSS-63-PP	GSS-63-PP B	Ø 63	63,3	66,0	100

Elbow Bend

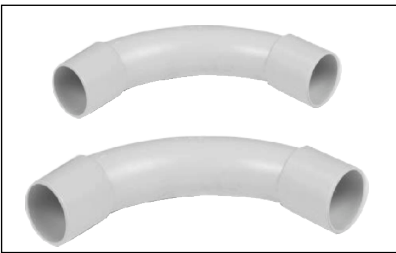

Grey: RAL:7035	White RAL:9003
-------------------	-------------------

GSS				Nominal Diameter	Inside D mm	Outside D,mm	Length mm
PVC Flame-retardant		PP Halogen Free					
Grey: RAL:7035	White RAL:9003	Grey: RAL:7035	White RAL:9003				
CRA-16-PVC	CRA-16-PVC B	CRA-16-PP	CRA-16-PP B	Ø 16	16,1	19,0	70
CRA-20-PVC	CRA-20-PVC B	CRA-20-PP	CRA-20-PP B	Ø 20	20,2	23,0	90
CRA-25-PVC	CRA-25-PVC B	CRA-25-PP	CRA-25-PP B	Ø 25	25,2	29,0	120
CRA-32-PVC	CRA-32-PVC B	CRA-32-PP	CRA-32-PP B	Ø 32	32,3	36,0	150

90° Elbow



Grey: RAL:7035	White RAL:9003
-------------------	-------------------

GSS				Nominal Diameter	Inside D mm	Outside D,mm	Length mm
PVC Flame-retardant		PP Halogen Free					
Grey: RAL:7035	White RAL:9003	Grey: RAL:7035	White RAL:9003				
ADS-16-PVC	ADS-16-PVC B	ADS-16-PP	ADS-16-PP B	Ø 16	16,1	16,1	38,5
ADS-20-PVC	ADS-20-PVC B	ADS-20-PP	ADS-20-PP B	Ø 20	20,2	20,2	47
ADS-25-PVC	ADS-25-PVC B	ADS-25-PP	ADS-25-PP B	Ø 25	25,2	25,2	57,5
ADS-32-PVC	ADS-32-PVC B	ADS-32-PP	ADS-32-PP B	Ø 32	32,3	32,3	66,5

T Joint



Grey: RAL:7035	White RAL:9003
-------------------	-------------------

GSS				Nominal Diameter	Inside D mm	Outside D,mm	Length mm
PVC Flame-retardant		PP Halogen Free					
Grey: RAL:7035	White RAL:9003	Grey: RAL:7035	White RAL:9003				
TBS-16-PVC	TBS-16-PVC B	TBS-16-PP	TBS-16-PP B	Ø 16	16,1	20,5	64,5
TBS-20-PVC	TBS-20-PVC B	TBS-20-PP	TBS-20-PP B	Ø 20	20,1	25,5	70
TBS-25-PVC	TBS-25-PVC B	TBS-25-PP	TBS-25-PP B	Ø 25	25,2	30,5	75
TBS-32-PVC	TBS-32-PVC B	TBS-32-PP	TBS-32-PP B	Ø 32	32,2	38,3	82,7



Flexible Couplings

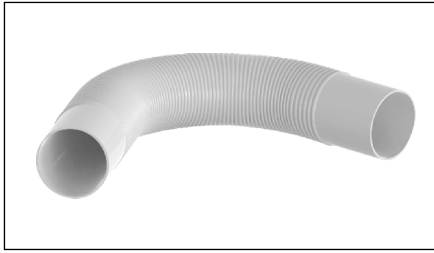

Grey: RAL:7035	White RAL:9003
-------------------	-------------------

ESM					
PVC Flame-retardant		Nominal Diameter	Inside D,mm	Outside D,mm	Length mm
Grey: RAL:7035	White RAL:9003				
ESM-16-PVC	ESM-16-PVC B	Ø 16	16,1	17,0	27,5
ESM-20-PVC	ESM-20-PVC B	Ø 20	20,1	21,3	27,5
ESM-25-PVC	ESM-25-PVC B	Ø 25	25,1	26,7	39,0
ESM-32-PVC	ESM-32-PVC B	Ø 32	32,1	32,1	39,0

Clip Halogen Free -PP



Grey: RAL:7035	White RAL:9003
-------------------	-------------------

CYS					
PP Halogen Free		Nominal Diameter	Inside D,mm	Outside D,mm	Length mm
Grey: RAL:7035	White RAL:9003				
CYS-16-PP	CYS-16-PP B	Ø 16	15,1	25,3	21,7
CYS-20-PP	CYS-20-PP B	Ø 20	19,2	30,0	28,2
CYS-25-PP	CYS-25-PP B	Ø 25	25	33,8	32,7
CYS-32-PP	CYS-32-PP B	Ø 32	31,2	40,2	41,0
CYS-40-PP	CYS-40-PP B	Ø 40	39,2	48,2	52,2
CYS-50-PP	CYS-50-PP B	Ø 50	49	59,2	64,18
CYS-63-PP	CYS-63-PP B	Ø 63	62,3	71,0	78,75

Clip with Cover Halogen Free -PP



Grey: RAL:7035	White RAL:9003
-------------------	-------------------

CFS					
PP Halogen Free		Nominal Diameter	Inside D,mm	Outside D,mm	Length mm
Grey: RAL:7035	White RAL:9003				
CFS-16-PP	CFS-16-PP B	Ø 16	16,1	16,1	38,5
CFS-20-PP	CFS-20-PP B	Ø 20	20,2	20,2	47,0
CFS-25-PP	CFS-25-PP B	Ø 25	25,2	25,2	57,5
CFS-32-PP	CFS-32-PP B	Ø 32	32,3	32,3	66,5

Rigid Pipe Adapter Halogen Free -PP



Grey: RAL:7035	White RAL:9003
-------------------	-------------------

DBS					
PP Halogen Free		Nominal Diameter	Inside D,mm	Outside D,mm	Length mm
Grey: RAL:7035	White RAL:9003				
DBS-16-PP	DBS-16-PP B	Ø 16	16,3	19,0	38,5
DBS-20-PP	DBS-20-PP B	Ø 20	20,3	22,5	47,0
DBS-25-PP	DBS-25-PP B	Ø 25	25,3	55,0	57,5
DBS-32-PP	DBS-32-PP B	Ø 32	32,3	65,0	66,5



PP Coupling Flame-retardant

PP Spiral Conduit Coupling – Halogen Free



Color Transparent	Grey: RAL:7035
----------------------	-------------------

GFS					
Code No	Nominal Diameter	Inner Ø (mm)	Outer Ø (mm)	Length (mm)	Packing (pcs)
GFS-16-S	Ø 16	16.4	19.4	50	100
GFS-16-S	Ø 20	20.5	23.5	55	100
GFS-25-S	Ø 25	25.5	29.5	55	100
GFS-32-S	Ø 32	32.5	36.5	60	100

Transparent		Standard Colour Transparent	
Code No	Nominal Diameter	Code No	Nominal Diameter
GFS-16-S	Ø 16	GFS-16-S	Ø 16
GFS-16-S	Ø 20	GFS-16-S	Ø 20
GFS-25-S	Ø 25	GFS-25-S	Ø 25
GFS-32-S	Ø 32	GFS-32-S	Ø 32

Color: RAL:7035		Optional Colour Gray / Gri	
Code No	Nominal Diameter	Code No	Nominal Diameter
GFS-16-G	Ø 16	GFS-16-G	Ø 16
GFS-16-G	Ø 20	GFS-16-G	Ø 20
GFS-25-G	Ø 25	GFS-25-G	Ø 25
GFS-32-G	Ø 32	GFS-32-G	Ø 32

PP Spiral Conduit Connector – Halogen Free



Grey: RAL:7035	White RAL:9003
-------------------	-------------------

SPK					
Code No	Nominal Diameter	Inner Ø (mm)	Outer Ø (mm)	Length (mm)	Packing (pcs)
SPK-16-PP	Ø 16	16.3	19.0	55	100
SPK-20-PP	Ø 20	20.3	22.5	55	100
SPK-25-PP	Ø 25	25.3	29.0	55	100

Color: RAL:7035		Standard Colour Gray / Gri	
Code No	Nominal Diameter	Code No	Nominal Diameter
SPK-16-PP	Ø 16	SPK-16-PP	Ø 16
SPK-20-PP	Ø 20	SPK-20-PP	Ø 20
SPK-25-PP	Ø 25	SPK-25-PP	Ø 25

White RAL:9003		Optional Colour White / Beyaz	
Code No	Nominal Diameter	Code No	Nominal Diameter
SPK-16-PP B	Ø 16	SPK-16-PP B	Ø 16
SPK-20-PP B	Ø 20	SPK-20-PP B	Ø 20
SPK-25-PP B	Ø 25	SPK-25-PP B	Ø 25

PP Spiral Conduit Connector With Cap – Halogen Free



Grey: RAL:7035	White RAL:9003
-------------------	-------------------

SBR					
Code No	Nominal Diameter	Inner Ø (mm)	Outer Ø (mm)	Length (mm)	Packing (pcs)
SBR-16-PP	Ø 16	16.3	19.0	55	100
SBR-20-PP	Ø 20	20.3	22.5	55	100
SBR-25-PP	Ø 25	25.3	29.0	55	100

Color: RAL:7035		Standard Colour Gray / Gri	
Code No	Nominal Diameter	Code No	Nominal Diameter
SBR-16-PP	Ø 16	SBR-16-PP	Ø 16
SBR-20-PP	Ø 20	SBR-20-PP	Ø 20
SBR-25-PP	Ø 25	SBR-25-PP	Ø 25

White RAL:9003		Optional Colour White / Beyaz	
Code No	Nominal Diameter	Code No	Nominal Diameter
SBR-16-PP B	Ø 16	SBR-16-PP B	Ø 16
SBR-20-PP B	Ø 20	SBR-20-PP B	Ø 20
SBR-25-PP B	Ø 25	SBR-25-PP B	Ø 25